

PIANI SCRITTOIO / WRITING DESK

Piani SQUADRATI SP. 3,8 cm

Bordo frontale e laterale Sp. 2mm, bordo posteriore carta Sp. 0,3 mm
Lateral and Frontal edge Th. 2 mm, paper back panel Th. 0,3 mm

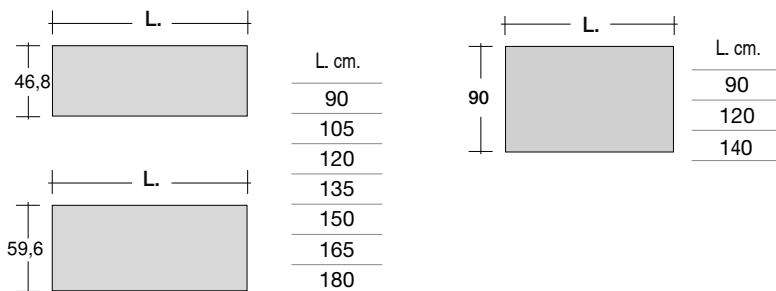

Piani STONDATI UN ANGOLO SP. 3,8 cm

Bordo Sp. 2mm, su quattro lati.
 Disegno Dx
*Edge Th. 2 mm, on four sides
 Rh drawing*

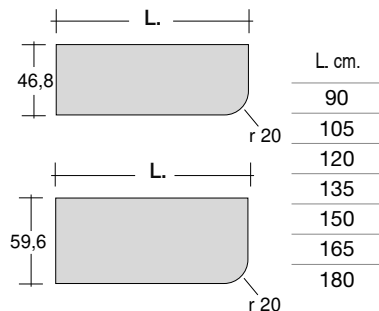

Piani SQUADRATI SP. 5,6 cm

Bordo frontale e laterale Sp. 2mm, bordo posteriore carta Sp. 0,3 mm
Lateral and Frontal edge Th. 2 mm, paper back panel Th. 0,3 mm

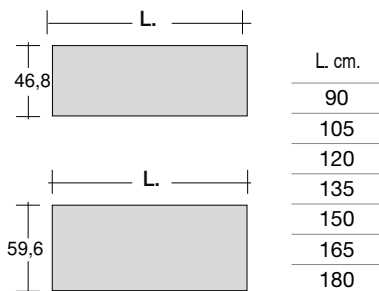

Piani STONDATI UN ANGOLO SP. 5,6 cm

Bordo Sp. 2mm, sui quattro lati.
 Disegno Dx
*Edge Th. 2 mm, on four sides
 Rh drawing*

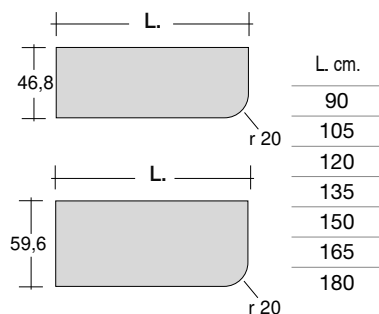

SCHEDA PRODOTTO / PRODUCT SHEET

COMPONENTI
COMPONENTS

SPESS.
THICK.

MATERIALI
MATERIALS

Pannelli: 3,8 / 5,6 cm Pannello in particelle di legno a basso contenuto di formaldeide.
Panels: Particle wooden panel with low containing of formaldehyde.

Finiture pannelli: [Nobilitato](#) [Lacc. Lucido](#)
Panels finishings: [Lacc. Opaco](#) [Lacc. Metal](#)

PIANI SCRITTOIO / WRITING DESK

Piani SAGOMATI SP. 3,8 cm

Bordo Sp. 2mm, sui quattro lati.
Edge Th. 2mm, on four sides

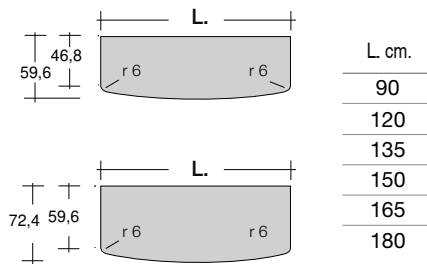

Piani SAGOMATI SP. 3,8 cm

Bordo Sp. 2mm, sui quattro lati.

disegno dx

Edge Th. 2mm, on four sides.

Rh drawing

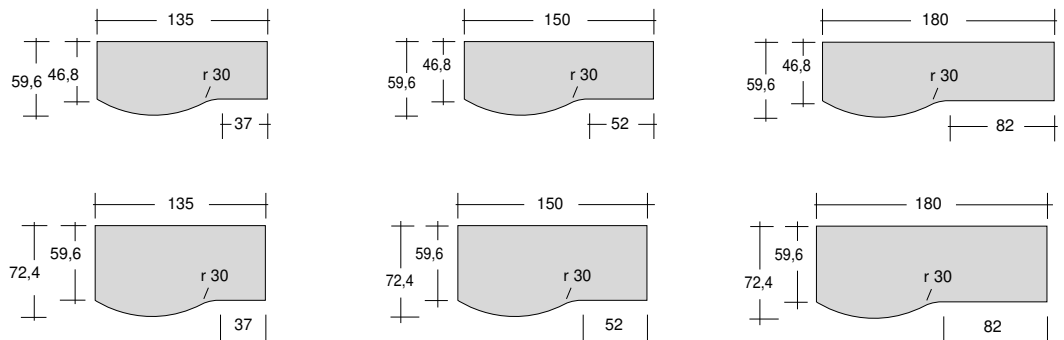

Piani SAGOMATI SP. 3,8 cm

Bordo Sp. 2mm, sui quattro lati.

disegno sx

Edge Th. 2mm, on four sides.

Lh drawing

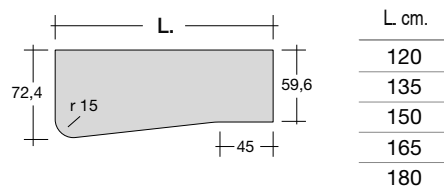

Piani SAGOMATI SP. 3,8 cm

Bordo Sp. 2mm, sui quattro lati.

Disegno sx

Edge Th. 2mm, on four sides.

Lh drawing

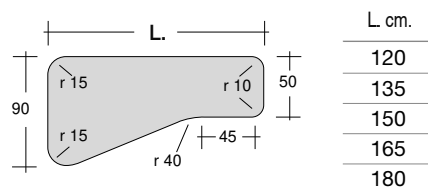

SCHEMA PRODOTTO / PRODUCT SHEET

COMPONENTI
COMPONENTS

SPESS.
THICK.

MATERIALI
MATERIALS

Pannelli:
Panels: 3,8 cm Pannello in particelle di legno a basso contenuto di formaldeide.
Particle wooden panel with low containing of formaldehyde.

Finiture pannelli:
Panels finishings: [Nobilitato](#) [Lacc. Lucido](#)
[Lacc. Opaco](#) [Lacc. Metal](#)

PIANI SCRITTOIO / WRITING DESK

Piani SAGOMATI SP. 3,8 cm

Bordo Sp. 2mm, sui quattro lati.
Edge Th. 2mm, on four sides

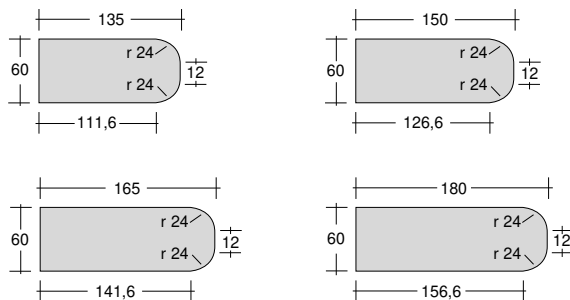

DINETTE SP. 3,8 cm

Il lato inserito nella colonna ha la stessa larghezza dei ripiani. Piani predisposti con fori per reggiriipiani.
Gambone non compreso.

disegno sx

The side inserted in the coloumn has the same width of the shelves. Top with holes for shelves supports.
Leg not included

Its drawing

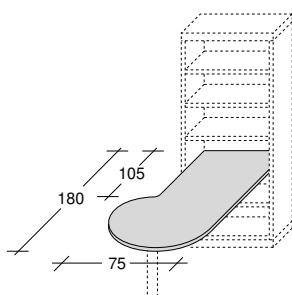

per colonna GLOBO L. 60 cm.
for coloumn GLOBO L. 60 cm

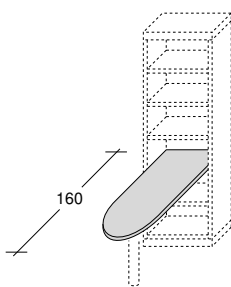

per colonna GLOBO L. 45 cm.
for coloumn GLOBO L. 45 cm

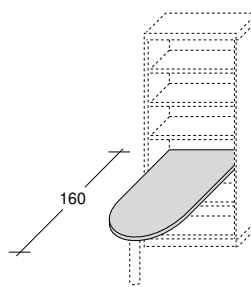

per colonna GLOBO L. 60 cm.
for coloumn GLOBO L. 60 cm

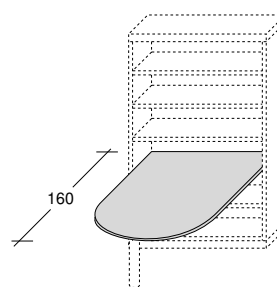

per colonna GLOBO L. 90 cm.
for coloumn GLOBO L. 90 cm

SCHEDA PRODOTTO / PRODUCT SHEET

COMPONENTI
COMPONENTS

SPESS.
THICK.

MATERIALI
MATERIALS

Pannelli:
Panels: 3,8 cm Pannello in particelle di legno a basso contenuto di formaldeide.
Particle wooden panel with low containing of formaldehyde.

Finiture pannelli:
Panels finishes: [Nobilitato](#) [Lacc. Lucido](#)
[Lacc. Opaco](#) [Lacc. Metal](#)

ELEMENTI DI SOSTEGNO PER PIANI SCRITTOIO / SUPPORTING ELEMENTS FOR WRITING DESKS

ELEMENTI H.68 cm

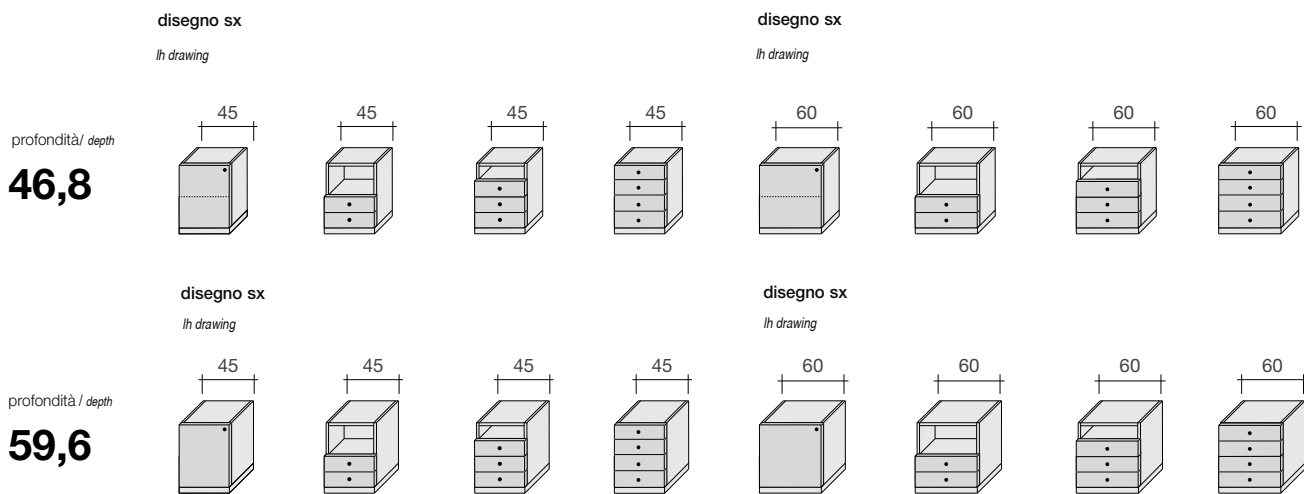

SCHEDA PRODOTTO / PRODUCT SHEET

COMPONENTI COMPONENTS	SPESS. THICK.	MATERIALI MATERIALS
Fianchi Sides	1,8 cm	Pannello in agglomerato di legno a basso contenuto di formaldeide. Wooden panel with low containing of formaldehyde.
Base Basement	3,8 cm	Pannello in agglomerato di legno a basso contenuto di formaldeide. Wooden panel with low containing of formaldehyde.
Coperchio Cover	1,8 cm	Pannello in agglomerato di legno a basso contenuto di formaldeide. Wooden panel with low containing of formaldehyde.
Schiena Back	0,5 cm	Pannello MDF, nobilitato su un lato. MDF Panel, melamine finish on 1 side.
Frontali Frontals	1,8 cm	Pannello in agglomerato di legno a basso contenuto di formaldeide. Wooden panel with low containing of formaldehyde.
Struttura cassetto Tray structure	1,2 cm	Pannello in agglomerato di legno a basso contenuto di formaldeide, rivestito in PVC. Wooden panels with low containing of formaldehyde covered by PVC
Guide cassetto Tray guides		Guida Quadro rallentata regolabile in altezza (portata 25 kg). Quadro slow guide adjustable in height (reach of 25 Kg).
Piedini Feet		H. 1 cm regolabili in altezza, realizzati in materiale plastico H. 1 cm adjustable in height, realized with plastic material
Maniglie Handles		Per maniglie disponibili clicca qui For available handle click here
Finiture per strutture Finishes for structure		Nobilitato Lacc. Lucido Lacc. Opaco Lacc. Metal
Finiture per frontali Finishes for frontals		Nobilitato Lacc. Lucido Lacc. Opaco Lacc. Metal

FIANCHI DI SOSTEGNO PER PIANI SCRITTOIO / SUPPORTING SIDES FOR WRITING DESKS

Fianchi a "L" sp. 2,8 cm.

"L" sides th. 2,8 cm

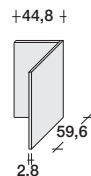
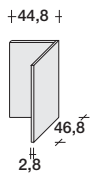

Fianchi di sostegno PANNELLO sp. 3,8 cm.

Specificare predisposizione sul piano (dx-sx)

Supporting sides PANEL th. 3,8 cm

Specify predisposition on the desk (rh - lh)

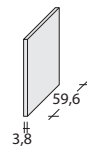
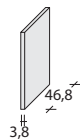

Fianchi di sostegno PANNELLO sp. 5,6 cm.

Specificare predisposizione sul piano (dx-sx)

Supporting sides PANEL th. 5,6 cm

Specify predisposition on the desk (rh - lh)

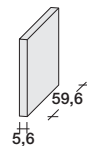
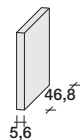

SCHEMA PRODOTTO / PRODUCT SHEET

COMPONENTI
COMPONENTS

SPESS.
THICK.

MATERIALI
MATERIALS

Pannelli:
Panels:

3,8 / 5,6 cm

Pannello in particelle di legno a basso contenuto di formaldeide.
Wooden panel with low containing of formaldehyde.

Finiture pannelli:
Panels finishes:

[Nobilitato](#)
[Lacc. Opaco](#)

[Lacc. Lucido](#)
[Lacc. Metal](#)

FIANCHI DI SOSTEGNO IN METALLO PER PIANI SCRITTOIO
SUPPORTING METAL SIDES FOR WRITING DESKS

Gamba FACTOR

Per utilizzo su piani scrivania Prof. 60 cm.
 Regolabile in altezza.

*For using on writing desks depth. 60 cm
 Adjustable in height.*

con piedini/ with feet

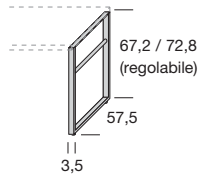

con ruote / on castors

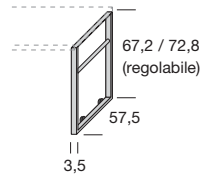

Sacca in tessuto per gamba Factor
Fabric bag for Factor leg

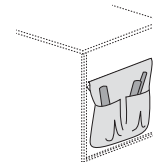

Gamba CORNER (coppia)

Non utilizzabile con piani sp. 1,8 cm.

Not usable with desks th. 1,8 cm

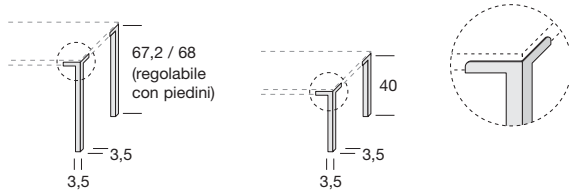

Gamba TEKA

Regolabile in altezza.

Utilizzabile su piani scrivania Prof. 60 e Prof. 47,2 cm (reversibile).
 Specificare verso SX o DX.

Adjustable in height. Usable on writing desks depth 60 and depth 47,2 (reversible). Specify if Rh or Lh.

Disegno DX / RH drawing

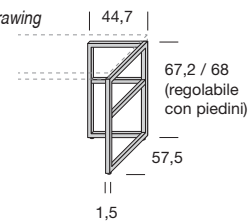

Gamba CILINDRO telescopica Ø 8 cm

Regolabile in altezza. / *Adjustable in height*

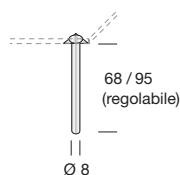

SCHEMA PRODOTTO / PRODUCT SHEET

COMPONENTI
 COMPONENTS

Struttura:
 Structure:

MATERIALI
 MATERIALS

Metallo verniciato a polveri epossidiche colore Bianco o Metal Grey oppure [Laccato Opaco](#)
 Painted metal with epoxy powder in White or Metal Grey finishings or [matt lacquered](#)

SCRITTOI - ESEMPI COMPOSIZIONI / WRITING DESKS-EXAMPLES OF COMP.

Scrivani H. 72 cm P.59,6 cm. con piano QUADRATO sp. 3,8 / 5,6 cm.

Writing desks H. 72 cm D.59,6 cm. with top SQUARED th. 3,8 / 5,6 cm.

Note

- Scrivani non finiti retro
Writing desks not back finished

	Prof. / Depth. 46,8	Prof. / Depth. 59,6	Prof. / Depth. 90
Scrivani con fianco a "L" sp. 2,8 cm. <i>Writing desks with "L" side th. 2,8 cm.</i> disegno dx / rh drawing	 L cm. _____ 120 _____ 135 _____ 150 _____ 165 _____ 180	 L cm. _____ 120 _____ 135 _____ 150 _____ 165 _____ 180	
Scrivani con gambe CILINDRO <i>Writing desks with CILINDRO legs</i> disegno dx / rh drawing	 L cm. _____ 120 _____ 135 _____ 150 _____ 165 _____ 180	 L cm. _____ 120 _____ 135 _____ 150 _____ 165 _____ 180	
Scrivani con gambe CORNER <i>Writing desks with CORNER legs</i> disegno dx / rh drawing	 L cm. _____ 120 _____ 135 _____ 150 _____ 165 _____ 180	 L cm. _____ 120 _____ 135 _____ 150 _____ 165 _____ 180	 L cm. _____ 90 _____ 120 _____ 140
Scrivani con gambe FACTOR <i>Writing desks with FACTOR legs</i> disegno dx / rh drawing	 L cm. _____ 120 _____ 135 _____ 150 _____ 165 _____ 180		

SCRITTOI - ESEMPI COMPOSIZIONI / WRITING DESKS- EXAMPLES OF COMPOSITIONS

Scrivani H. 72 cm P.59,6 cm. con piano QUADRATO sp. 3,8 / 5,6 cm.

Writing desks H. 72 cm D.59,6 cm. with top SQUARED th. 3,8 / 5,6 cm.

Note

- Scrivani non finiti retro
Writing desks not back finished

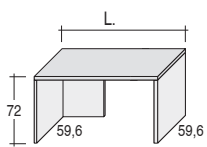
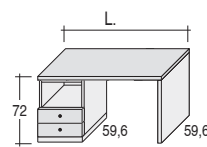
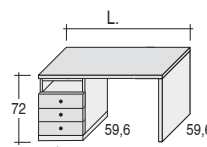
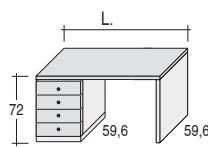
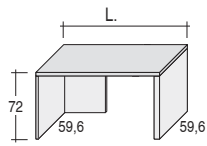
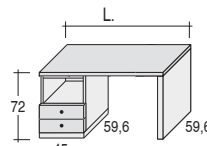
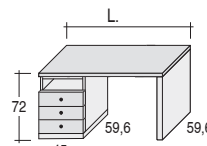
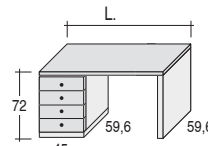
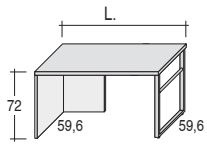
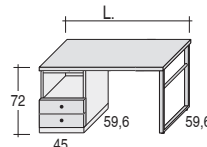
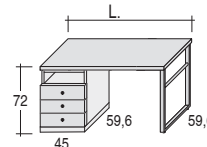
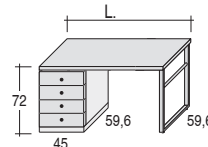
	con fianco a "L" sp. 2,8 cm. <i>with "L" side th. 2,8 cm.</i>	con elemento a 2 cassetti <i>With 2 drawers element</i>	con elemento a 3 cassetti <i>With 3 drawers element</i>	con elemento a 4 cassetti <i>With 4 drawers element</i>
Fianco di sost. PANNELLO Sp. 3,8 cm. <i>Supporting side PANEL Th. 3,8 cm.</i> disegno dx / rh drawing	 <p>L. cm.</p> <p>120</p> <p>135</p> <p>150</p> <p>165</p> <p>180</p>	 <p>L. cm.</p> <p>120</p> <p>135</p> <p>150</p> <p>165</p> <p>180</p>	 <p>L. cm.</p> <p>120</p> <p>135</p> <p>150</p> <p>165</p> <p>180</p>	 <p>L. cm.</p> <p>120</p> <p>135</p> <p>150</p> <p>165</p> <p>180</p>
Fianco di sost. PANNELLO Sp. 5,6 cm. <i>Supporting side PANEL Th. 5,6 cm.</i> disegno dx / rh drawing	 <p>L. cm.</p> <p>120</p> <p>135</p> <p>150</p> <p>165</p> <p>180</p>	 <p>L. cm.</p> <p>120</p> <p>135</p> <p>150</p> <p>165</p> <p>180</p>	 <p>L. cm.</p> <p>120</p> <p>135</p> <p>150</p> <p>165</p> <p>180</p>	 <p>L. cm.</p> <p>120</p> <p>135</p> <p>150</p> <p>165</p> <p>180</p>
Gamba FACTOR <i>FACTOR leg</i> disegno dx / rh drawing	 <p>L. cm.</p> <p>120</p> <p>135</p> <p>150</p> <p>165</p> <p>180</p>	 <p>L. cm.</p> <p>120</p> <p>135</p> <p>150</p> <p>165</p> <p>180</p>	 <p>L. cm.</p> <p>120</p> <p>135</p> <p>150</p> <p>165</p> <p>180</p>	 <p>L. cm.</p> <p>120</p> <p>135</p> <p>150</p> <p>165</p> <p>180</p>

SCRITTOI - ESEMPI COMPOSIZIONI / WRITING DESKS- EXAMPLES OF COMPOSITIONS

Scrivani H. 72 cm. P.59,6cm con piano SAGOMATO sp. 3,8 cm.

Writing desks H. 72 cm D.59,6 cm. with top SHAPED th. 3,8 / 5,6 cm.

Note

- Scrivani non finiti retro
Writing desks not back finished

		con fianco a "L" sp. 2,8 cm. <i>with "L" side th. 2,8 cm.</i>	con elemento a 2 cassetti <i>With 2 drawers element</i>	con elemento a 3 cassetti <i>With 3 drawers element</i>	con elemento a 4 cassetti <i>With 4 drawers element</i>
Fianco di sost. PANNELLO Sp. 3,8 cm. <i>Supporting side PANEL Th. 3,8 cm.</i> disegno dx / th drawing					
	L. cm.	L. cm.	L. cm.	L. cm.	
	120 135 150 165 180	120 135 150 165 180	120 135 150 165 180	120 135 150 165 180	
Fianco di sost. PANNELLO Sp. 5,6 cm. <i>Supporting side PANEL Th. 5,6 cm.</i> disegno dx / th drawing					
	L. cm.	L. cm.	L. cm.	L. cm.	
	120 135 150 165 180	120 135 150 165 180	120 135 150 165 180	120 135 150 165 180	
Gamba FACTOR <i>FACTOR leg</i> disegno dx / th drawing					
	L. cm.	L. cm.	L. cm.	L. cm.	
	120 135 150 165 180	120 135 150 165 180	120 135 150 165 180	120 135 150 165 180	

SCRITTOI - ESEMPI COMPOSIZIONI / WRITING DESKS- EXAMPLES OF COMPOSITIONS

Scrivani H. 72 cm. P.59,6cm con piano SAGOMATO sp. 3,8 cm.

Writing desks H. 72 cm D.59,6 cm. with top SHAPED th. 3,8 / 5,6 cm.

Note

- Scrivani non finiti retro
Writing desks not back finished

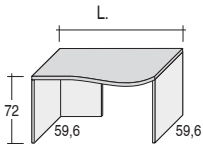
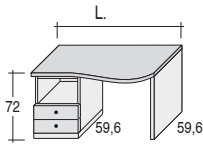
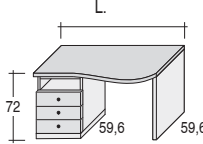
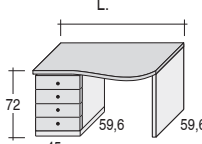
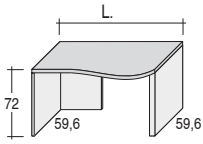
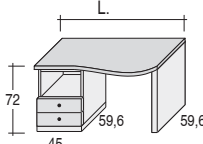
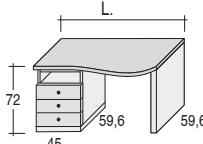
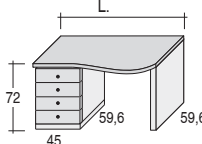
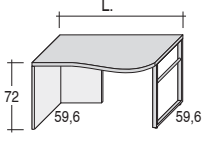
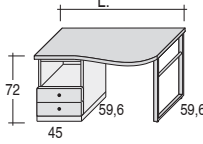
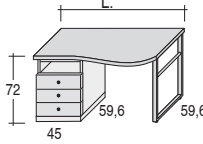
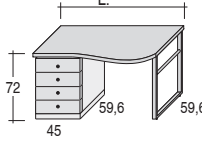
	con fianco a "L" sp. 2,8 cm. <i>with "L" side th. 2,8 cm.</i>	con elemento a 2 cassetti <i>With 2 drawers element</i>	con elemento a 3 cassetti <i>With 3 drawers element</i>	con elemento a 4 cassetti <i>With 4 drawers element</i>
Fianco di sost. PANNELLO Sp. 3,8 cm. <i>Supporting side PANEL Th. 3,8 cm.</i>	 <p>L. cm.</p> <p>120</p> <p>135</p> <p>150</p> <p>165</p> <p>180</p>	 <p>L. cm.</p> <p>120</p> <p>135</p> <p>150</p> <p>165</p> <p>180</p>	 <p>L. cm.</p> <p>120</p> <p>135</p> <p>150</p> <p>165</p> <p>180</p>	 <p>L. cm.</p> <p>120</p> <p>135</p> <p>150</p> <p>165</p> <p>180</p>
Fianco di sost. PANNELLO Sp. 5,6 cm. <i>Supporting side PANEL Th. 5,6 cm.</i>	 <p>L. cm.</p> <p>120</p> <p>135</p> <p>150</p> <p>165</p> <p>180</p>	 <p>L. cm.</p> <p>120</p> <p>135</p> <p>150</p> <p>165</p> <p>180</p>	 <p>L. cm.</p> <p>120</p> <p>135</p> <p>150</p> <p>165</p> <p>180</p>	 <p>L. cm.</p> <p>120</p> <p>135</p> <p>150</p> <p>165</p> <p>180</p>
Gamba FACTOR <i>FACTOR leg</i>	 <p>L. cm.</p> <p>120</p> <p>135</p> <p>150</p> <p>165</p> <p>180</p>	 <p>L. cm.</p> <p>120</p> <p>135</p> <p>150</p> <p>165</p> <p>180</p>	 <p>L. cm.</p> <p>120</p> <p>135</p> <p>150</p> <p>165</p> <p>180</p>	 <p>L. cm.</p> <p>120</p> <p>135</p> <p>150</p> <p>165</p> <p>180</p>

SCRITTOI - ESEMPI COMPOSIZIONI / WRITING DESKS- EXAMPLES OF COMPOSITIONS

Scrivani H. 72 cm. P.59,6cm con piano SAGOMATO sp. 3,8 cm.

Writing desks H. 72 cm D.59,6 cm. with top SHAPED th. 3,8 / 5,6 cm.

Note

- Scrivani non finiti retro
Writing desks not back finished

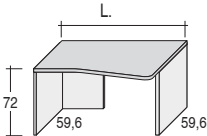
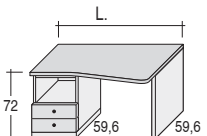
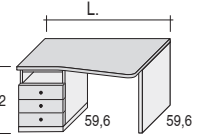
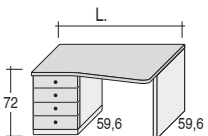
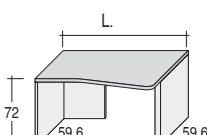
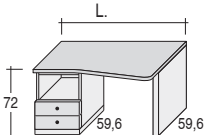
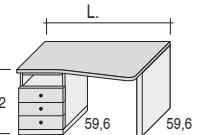
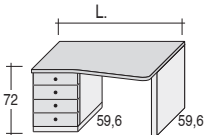
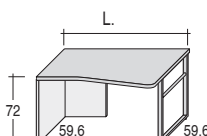
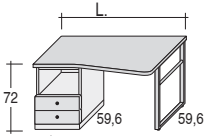
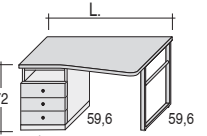
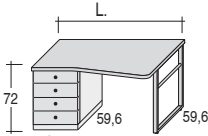
	con fianco a "L" sp. 2,8 cm. <i>with "L" side th. 2,8 cm.</i>	con elemento a 2 cassetti <i>With 2 drawers element</i>	con elemento a 3 cassetti <i>With 3 drawers element</i>	con elemento a 4 cassetti <i>With 4 drawers element</i>
Fianco di sost. PANNELLO Sp. 3,8 cm. <i>Supporting side PANEL Th. 3,8 cm.</i> disegno dx / rh drawing	 <p>L. cm.</p> <p>120</p> <p>135</p> <p>150</p> <p>165</p> <p>180</p>	 <p>L. cm.</p> <p>120</p> <p>135</p> <p>150</p> <p>165</p> <p>180</p>	 <p>L. cm.</p> <p>120</p> <p>135</p> <p>150</p> <p>165</p> <p>180</p>	 <p>L. cm.</p> <p>120</p> <p>135</p> <p>150</p> <p>165</p> <p>180</p>
Fianco di sost. PANNELLO Sp. 5,6 cm. <i>Supporting side PANEL Th. 5,6 cm.</i> disegno dx / rh drawing	 <p>L. cm.</p> <p>120</p> <p>135</p> <p>150</p> <p>165</p> <p>180</p>	 <p>L. cm.</p> <p>120</p> <p>135</p> <p>150</p> <p>165</p> <p>180</p>	 <p>L. cm.</p> <p>120</p> <p>135</p> <p>150</p> <p>165</p> <p>180</p>	 <p>L. cm.</p> <p>120</p> <p>135</p> <p>150</p> <p>165</p> <p>180</p>
Gamba FACTOR FACTOR leg disegno dx / rh drawing	 <p>L. cm.</p> <p>120</p> <p>135</p> <p>150</p> <p>165</p> <p>180</p>	 <p>L. cm.</p> <p>120</p> <p>135</p> <p>150</p> <p>165</p> <p>180</p>	 <p>L. cm.</p> <p>120</p> <p>135</p> <p>150</p> <p>165</p> <p>180</p>	 <p>L. cm.</p> <p>120</p> <p>135</p> <p>150</p> <p>165</p> <p>180</p>

SCRITTOI H.72 cm CON SCHIENA / WRITING DESKSH.72 cm WITH BACK

Note

- Scrivani non finiti retro
Writing desks not back finished

SCRITTOI P.46,8 cm

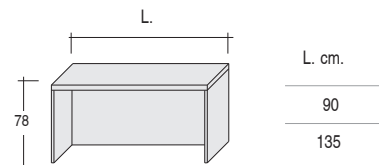
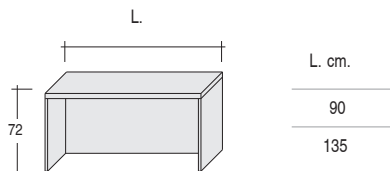

SCRITTOI P.59,6 cm

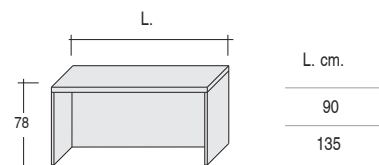
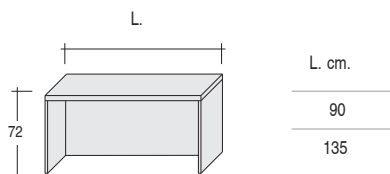

SCHEDA PRODOTTO / PRODUCT SHEET

COMPONENTI <i>COMPONENTS</i>	SPESS. <i>THICK.</i>	MATERIALI <i>MATERIALS</i>
Piano: <i>Piano:</i>	3,8 cm	Pannello in particelle di legno a basso contenuto di formaldeide. <i>Wooden panel with low containing of formaldehyde.</i>
Fianchi: <i>Fianchi:</i>	1,8 cm	Pannello in particelle di legno a basso contenuto di formaldeide. <i>Wooden panel with low containing of formaldehyde.</i>
Schiena: <i>Schiena:</i>	1,8 cm	Pannello in particelle di legno a basso contenuto di formaldeide. <i>Wooden panel with low containing of formaldehyde.</i>
Finiture: <i>Finiture:</i>		Nobilitato Lacc. Lucido Lacc. Opaco Lacc. Metal

Cassettiere

Cassettiere

• ruote con bloccaggio, cassetto superiore c/serratura (finita retro)
 Finiture struttura: Nobilitato, Lacc. Opaco, Lacc. Lucido, Lacc. Metal
 Finiture frontali: Nobilitato, Lacc. Opaco, Lacc. Gessato, Lacc. Lucido, Lacc. Metal

Castors with block system, superior drawer with lock (back finished)
 Structure finishings: Nobilitato, Lacc. Opaco, Lacc. Lucido, Lacc. Metal
 Frontal finishings: Nobilitato, Lacc. Opaco, Lacc. Gessato, Lacc. Lucido, Lacc. Metal

Cassettiera 3 cassetti
 Drawer 3 drawers



cm. 45 x 46,8 x 60,5 h.

Cassettiera 3 cassetti s/serratura
 Drawer 3 drawers w/out lock



cm. 45 x 46,8 x 60,5 h.

Cassettiera 1 cassetto e raccoglitore
 Drawer 1 tray and binder



cm. 45 x 46,8 x 60,5 h.

Porta computer

Computer-hanger

Portacomputer con supporti.
 Tavolettina in MDF finitura Metal Grey o laccato opaco.
 Suspended computer-hanger with supports
 MDF tablet Metal Grey finishing or matt lacquered.

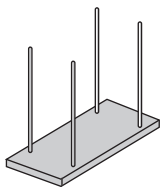

Portacomputer su ruote.
 Tavolettina in MDF finitura Metal Grey o laccato opaco.
 Computer-hanger on castors
 MDF tablet Metal Grey finishing or matt lacquered.

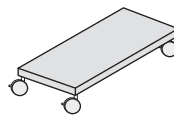

Boccole passacavi

Boccole passacavi

Indicare la posizione del foro:
 DX, SX o centrale
 Indicate the hole position. RH, LH or central

In plastica finitura Metal Grey
 In plastic finishing Metal grey

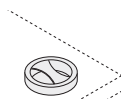

Ø 6 cm.

In metallo finitura Metal Grey
 In metal finishing Metal grey

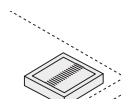

8 x 8 cm.

In plastica finitura Metal Grey
 In plastic finishing Metal grey

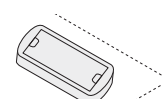

10,9 x 4,6 cm

Staffe

Brackets

Confezione 4 staffe di unione per piani scrittoio
 Packaging of 4 joint brackets for writing desks

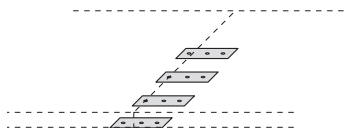

Staffa per scrittoio sospeso
 Bracket for suspended writing desk

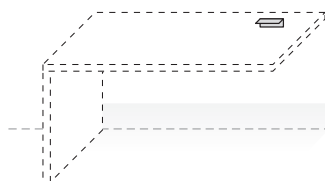

PIANI SOSPESI JUMP Sp. 5,6 / SUSPENDED JUMP TOPS Th. 5,6

Piano in appoggio comprensivo di staffe di fissaggio a muro. Si consiglia il montaggio su pareti in muratura per garantire una portata ottimale.
Supporting desk top with fixing brackets on the wall. We recommend the fixing on brick wall to guarantee an optimal capacity.



SCHEDA PRODOTTO / PRODUCT SHEET

COMPONENTI COMPONENTS	SPESS. THICK.	MATERIALI MATERIALS
Piano: Top:	5,6 cm.	Pannello superiore Sp.1,8cm con cornice perimetrale (laterali + frontale) Sp. 3,8cm, realizzati con pannello in particelle di legno a basso contenuto di formaldeide. Superior panel Th.1,8cm with perimeter (laterals + frontals) Th. 3,8cm, realized with particle wooden panel of low containing of formaldehyde
Pannelli alzata: High panels:	2,2 cm.	Pannello in particelle di legno a basso contenuto di formaldeide. Wooden panel with low containing of formaldehyde.
Profili di finitura: finishing profiles:	1,5 x 1,5 cm.	Profilo ad "L" in alluminio Aluminium "L" profile
Finiture Finishes		Nobilitato Lacc. Lucido Lacc. Opaco Lacc. Metal

Note

- Bordatura: frontale e laterali bordo ABS sp. 1 mm, posteriore bordo carta sp. 0,3 mm.
Edge: frontal and lateral ABS th. 1 mm, paper back edge th. 0,3 mm.
- Lunghezza massima 240 cm
Maximum length 240 cm

PIANI SOSPESI JUMP Sp. 5,6 / SUSPENDED JUMP TOPS Th. 5,6

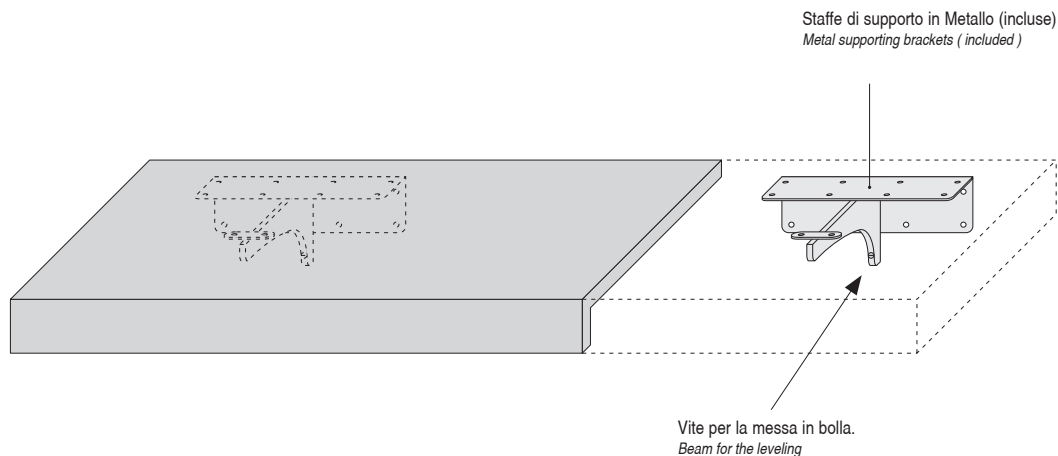

DIMENSIONI / DIMENSIONS

Prof. / Depth 34,4 cm		Prof. / Depth 47,2 cm	
	Largh.		Largh.
	Largh.		Largh.
	cm		cm
	120		120
	150		150
	180		180
210	210		
240	240		

STAFFE DI SUPPORTO IN METALLO / METAL SUPPORTING BRACKETS

Include / Included
 da L.120 a L.180 : n. 2
 da L.181 a L. 240 : n. 3

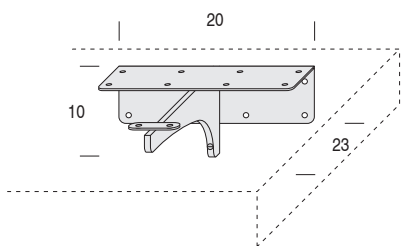

PIANI SOSPESI JUMP Sp. 5,6 cm CON ALZATA

SUSPENDED JUMP TOPS Th. 5,6 WITH RAISED

Prof. / Depth 34,4 cm

H. totale / H. total
37,6 cm

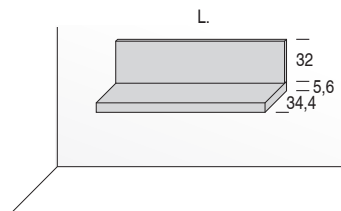

Largh. cm
120
150
180
210
240

Prof. / Depth 47,2 cm

H. totale / H. total
37,6 cm

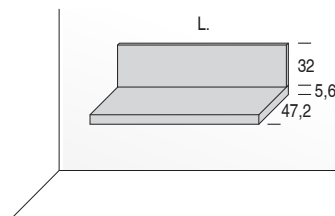

Largh. cm
120
150
180
210
240

H. totale / H. total
69,6 cm

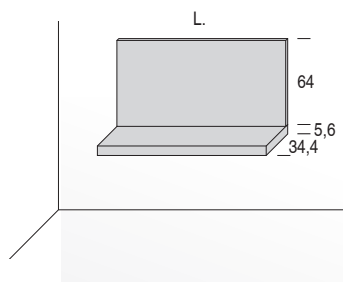

Largh. cm
120
150
180
210
240

H. totale / H. total
69,6 cm

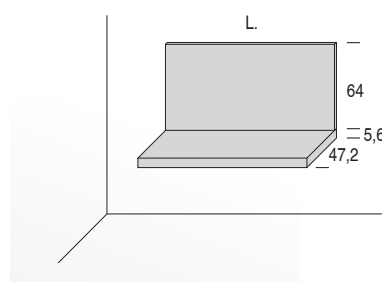

Largh. cm
120
150
180
210
240

PROFILO DI FINITURA / FINISHING PROFILE

Profilo di finitura superiore e laterale in alluminio anodizzato (completo di clips di montaggio). Lunghezza massima 300 cm.
Abbinabile a strip LED con alimentatore (ved sotto).

Lateral and superior finishing profile in anodized aluminium (complete of assembly clips).
Maximum length 300 cm.
Matchable to strip LED with power supply (see below).

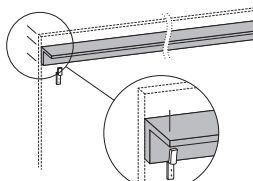

Posizionamento profili di finitura

Positioning of the finishing profile

alzata in appoggio su piano.
raised in support on the top

alzata in appoggio su piano e parete laterale.
raised in support on top and on lateral wall

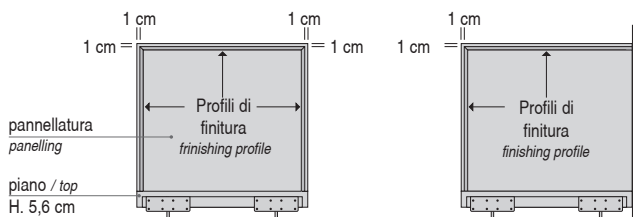

STRIP LED (120 LED/m) / STRIP LED (120 LED/m)

Applicazione: adesiva
Application: adhesive

Tonalità luce: 3000k
Light tonality: 3000k

Strip LED flessibile con sistema di connessione rapida che permette di collegare in fila continua moduli di diverse larghezze (max 6 m). I moduli sono divisibili ogni 5 cm. Da abbinare ad alimentatore 30 Watt 24 Vdc.
Strip LED flexible with quick connecting system that permit to connect in a continuous line modules of different widths (max 6 m). The items are divisible every 5 cm. To match to power supply 30 Watt 24 Vdc.

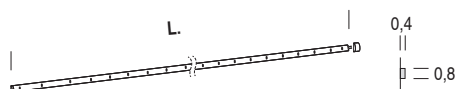

L. cm	Potenza Power W
100	9,6
200	19,2

Alimentatore per Strip LED / Power supply for Strip LED

Input: 230 V

Output: 24 Vdc

Potenza massima 30 W con morsetteria a 9 vie.

Input: 230 V

Output: 24 Vdc

Maximum power 30 W with 9 ways terminal block.

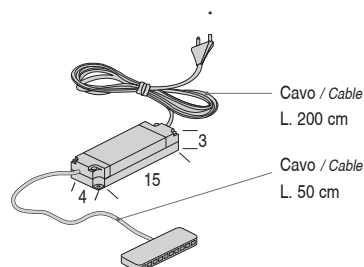

SCRITTOIO SOSPESO CLOUD / SCRITTOIO SOSPESO CLOUD

Scrivania sospesa con libreria a giorno sul lato destro. / *Suspended writing desk with open library on the right side*

SCHEDA PRODOTTO / PRODUCT SHEET

COMPONENTI <i>COMPONENTS</i>	SPESS. <i>THICK.</i>	MATERIALI <i>MATERIALS</i>
Spalle: <i>Sides:</i>	2,8 cm.	Pannello in particelle di legno a basso contenuto di formaldeide. <i>Wooden panel with low containing of formaldehyde.</i>
Piano scrivania: <i>Desk top:</i>	2,8 cm.	Pannello in particelle di legno a basso contenuto di formaldeide. <i>Wooden panel with low containing of formaldehyde.</i>
Ripiano: <i>Shelf:</i>	2,8 cm.	Pannello in particelle di legno a basso contenuto di formaldeide. <i>Wooden panel with low containing of formaldehyde.</i>
Coperchio: <i>Cover:</i>	2,8 cm.	Pannello in particelle di legno a basso contenuto di formaldeide. <i>Wooden panel with low containing of formaldehyde.</i>
Schiena monofacciale: <i>"monofacciale" back:</i>	1,8 cm.	Pannello in particelle di legno a basso contenuto di formaldeide. <i>Wooden panel with low containing of formaldehyde.</i>
Finiture monofacciale: <i>"monofacciale" back:</i>	1,8 cm.	Pannello in particelle di legno a basso contenuto di formaldeide. <i>Wooden panel with low containing of formaldehyde.</i>
Finiture <i>Finishes</i>		Nobilitato Lacc. Opaco

SPAGNOLMOBILI

SCRITTOIO SOSPESO CLOUD E ACCESSORI

CLOUD SUSPENDED WRITING DESK AND ACCESSORIES

Note

- Tutte le spalle sono dotate di attaccaglia regolabile per il montaggio a muro. L'attaccaglia è garantita per una portata massima di 65 kg. cad.
All the sides have the adjustable support for the fixing on the wall. The support can reach of 65 kg. each.
- Lo scrittoio viene fornito con vano libreria esclusivamente sul lato destro.
The writing desk is furnished with the open library only on the right side.

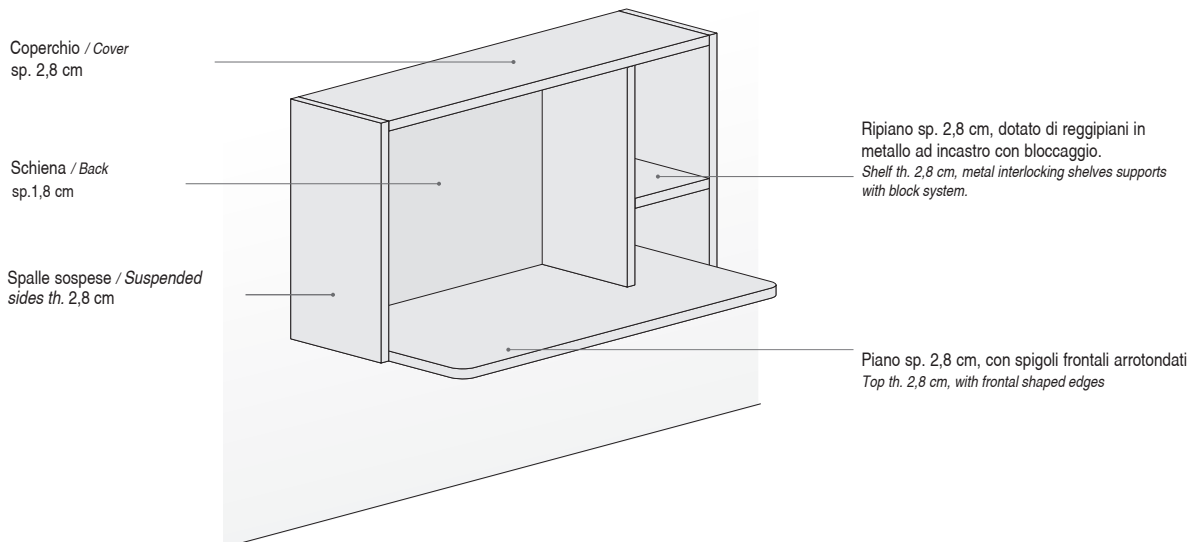

DIMENSIONI / DIMENSIONS

Vano libreria disponibile esclusivamente sul lato destro.
The unit is furnished with the open library only on the right side.

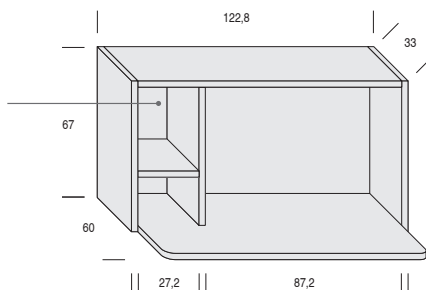

ACCESSORI PER SCRITTOIO CLOUD / ACCESSORIES FOR WRITING DESK CLOUD

Lampada K-PAD (con interruttore) / Lamp K-PAD (with switch)

Applicazione: sotto pensile, sotto mensola.

Finitura: Metal Grey.

Tonalità luce: 3000k

Kit lampada di superficie a LED con interruttore a sfioro, dimmerabile, completo di alimentatore 15 W / 24 Vdc con morsetteria a 9 vie.

Application: under suspended unit, under shelf.

Finishing: Metal Grey.

Light tonality: 3000k

Kit lamp LED surface with touch switch, dimmable, with power supply 15 W / 24 Vdc with 9 ways terminal block.

